

Data Sheet



Article number: 20329300

Description: E+G Handwheel
GN 555-125-B14-A

Measures

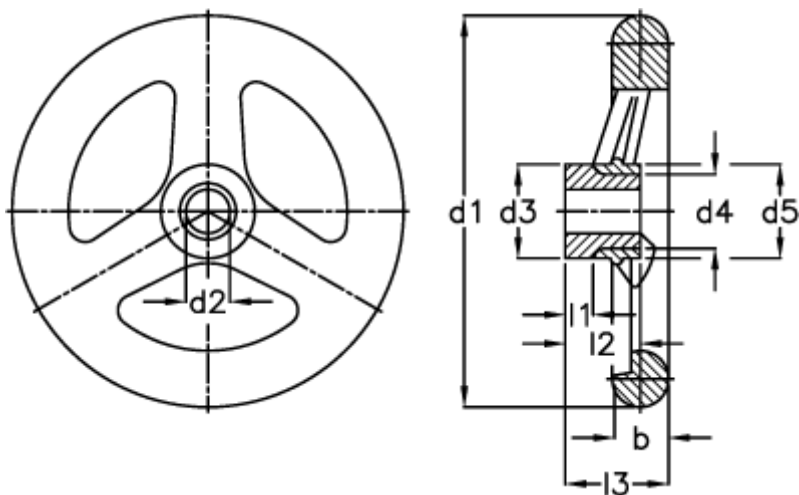

b	= 18	l2 -0.5	= 25
d1	= 125	l3	= 34
d2 H7	= 14	Number of spokes	= 3
d2 H7	= 12		
d3	= 24		
d4	= 18		
d5	= 30		
l1 -0.5	= 1		